

99ER-002: Système de relevage / Lift kit

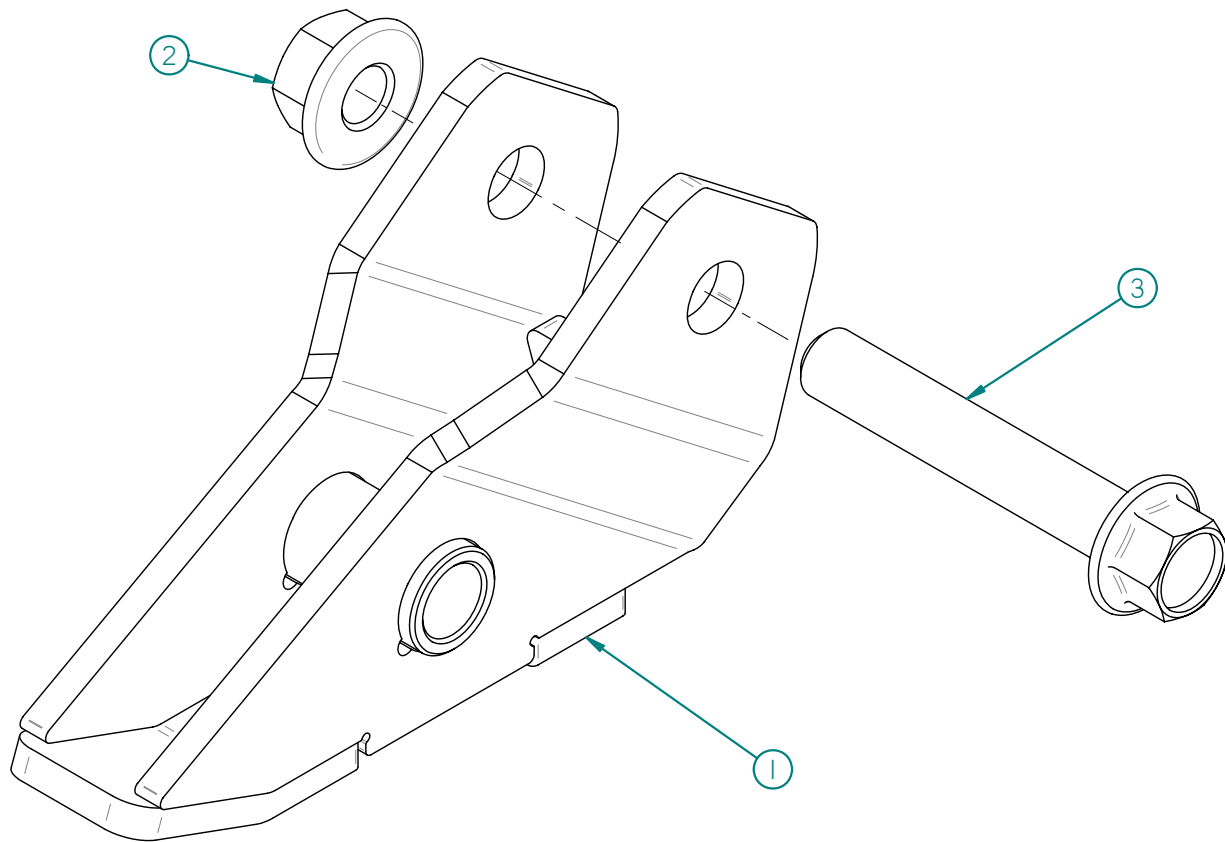

Liste des pièces / Part List

RÉF	# PIECE/PART	QTÉ/QTY
1	03ER-002	2
2	HFN-M10	2
3	HFBM10x1.5x60G8	2

2007-03-16



Installation du système de relevage

Cette image représente le VTT avant modification.

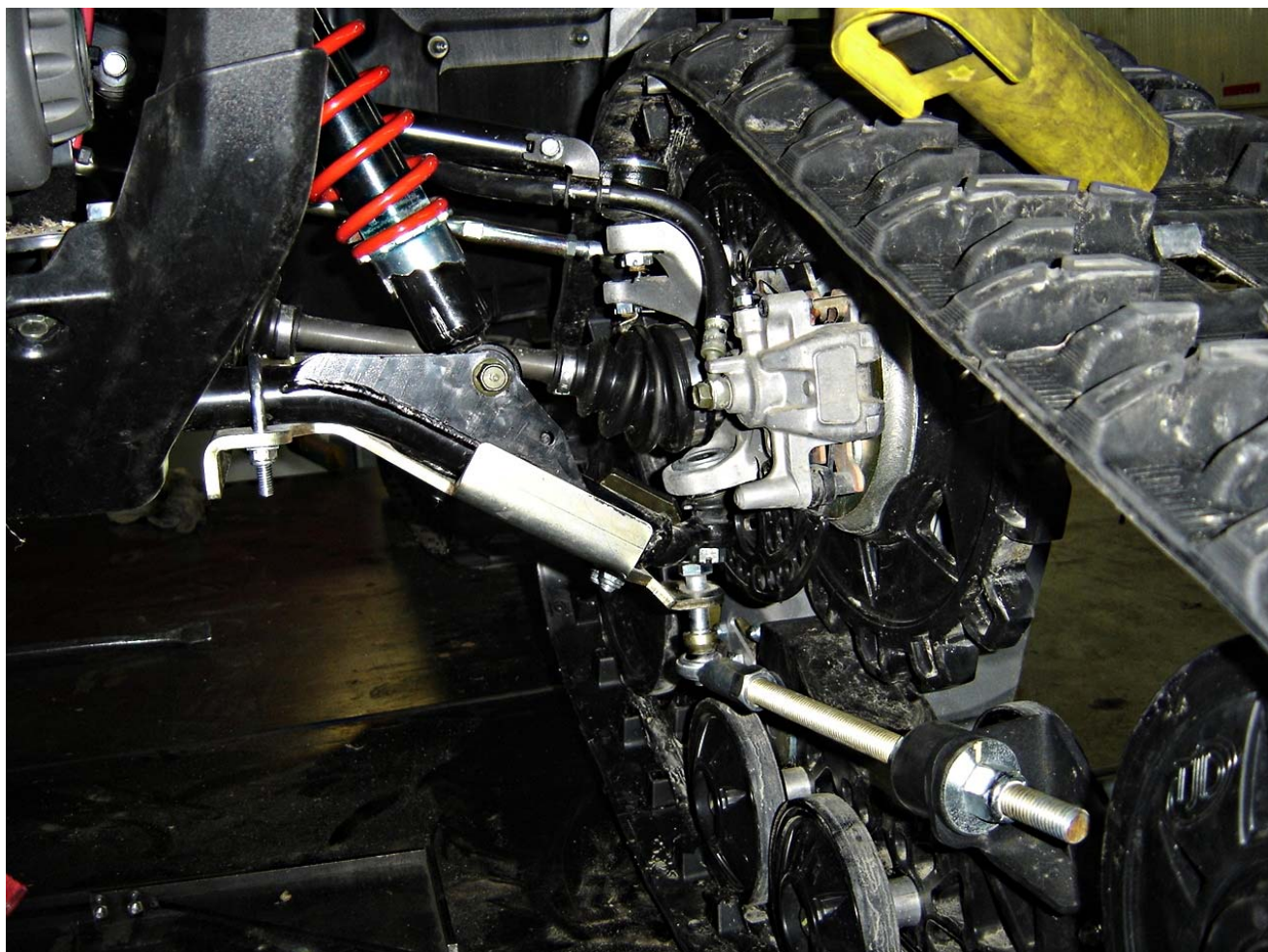

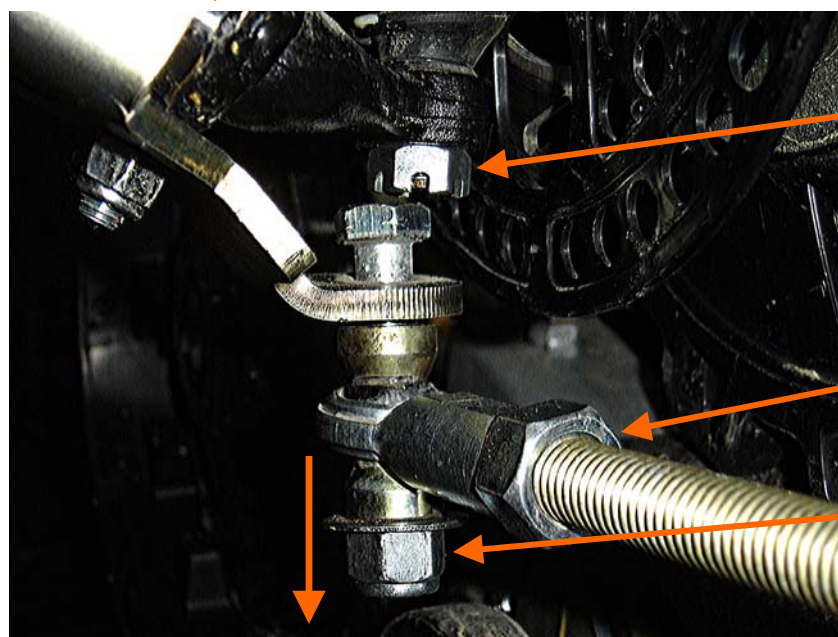
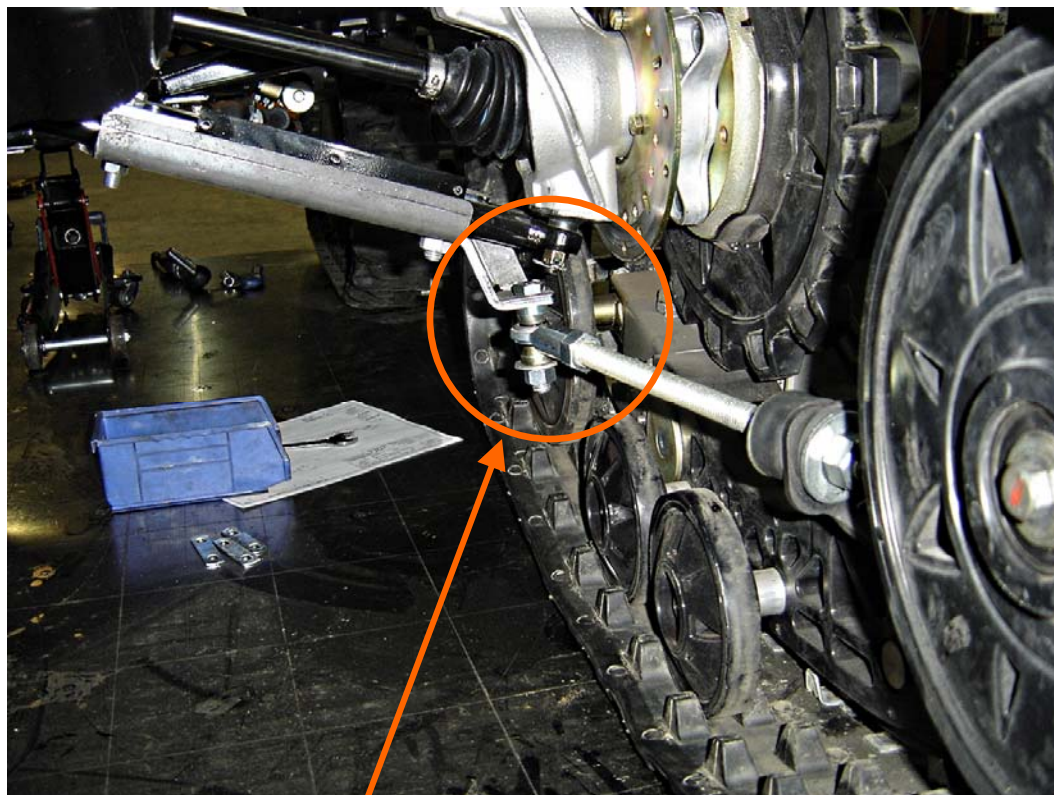

- Soulever le VTT, enlever l'écrou (item 2) pour ensuite enlever la rotule et la tige filetée (item 1) en la glissant vers le bas.
- Enlever l'écrou. (item3)



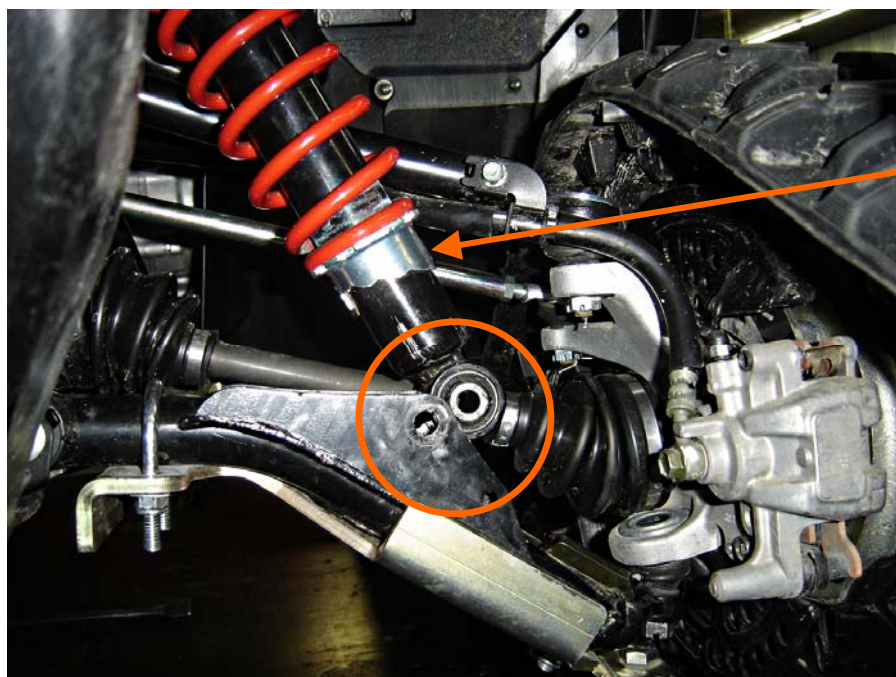

- Détendre le cylindre afin de faciliter l'installation. (item 4)
- Enlever le boulon d'origine pour dégager le cylindre. (voir la partie encerclée.)

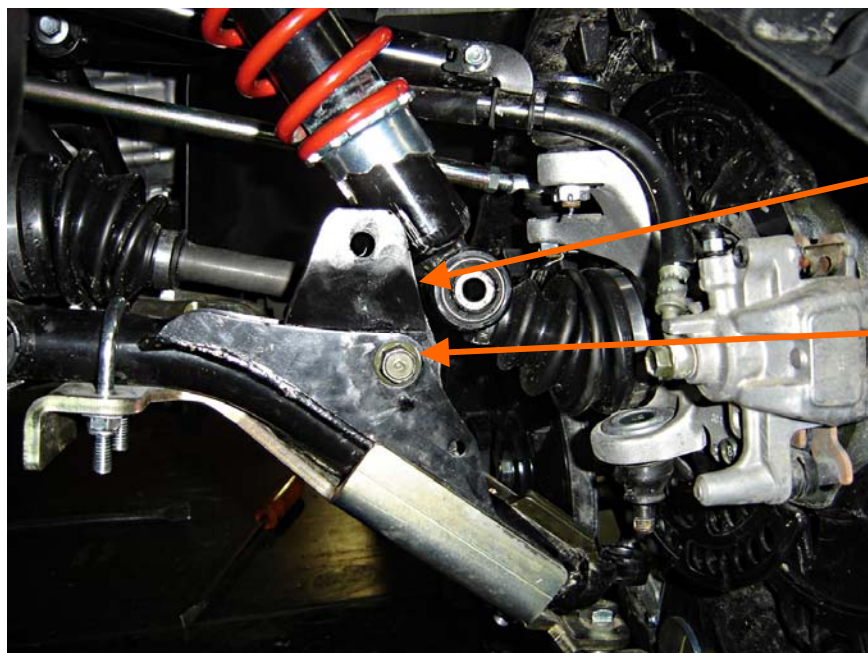

- Placer le système de relevage (item 5) sur la table de roue.
- Réinstaller le boulon d'origine. (item 6)



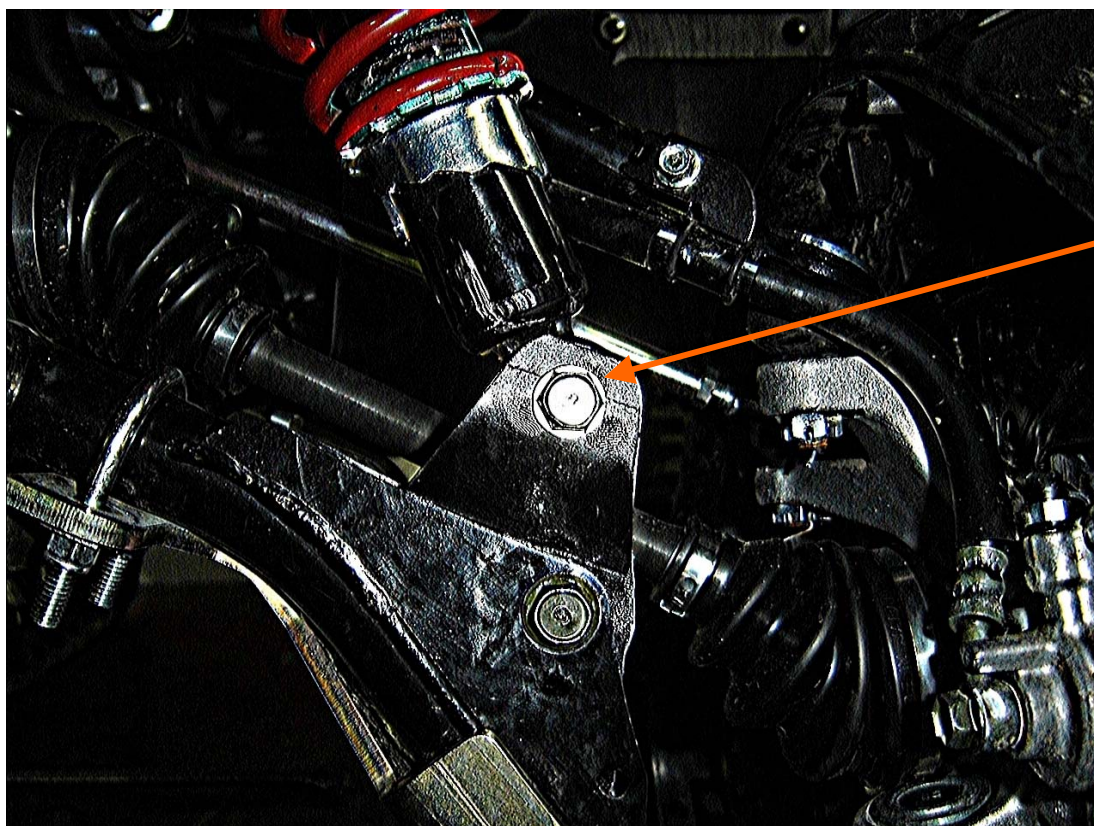

- Installer le deuxième boulon. (item 7)

*Important : ne pas serrer excessivement pour ne pas bloquer le cylindre.

- Répéter les étapes pour l'autre côté du véhicule.
- Réajuster la suspension au plus rigide.

⚠ Important d'utiliser cet assemblage avec le système de chenille xgen seulement.



Lift kit installation procedure

This picture shows the lift kit before installation.



Lift kit installation procedure

This picture shows the lift kit before installation.



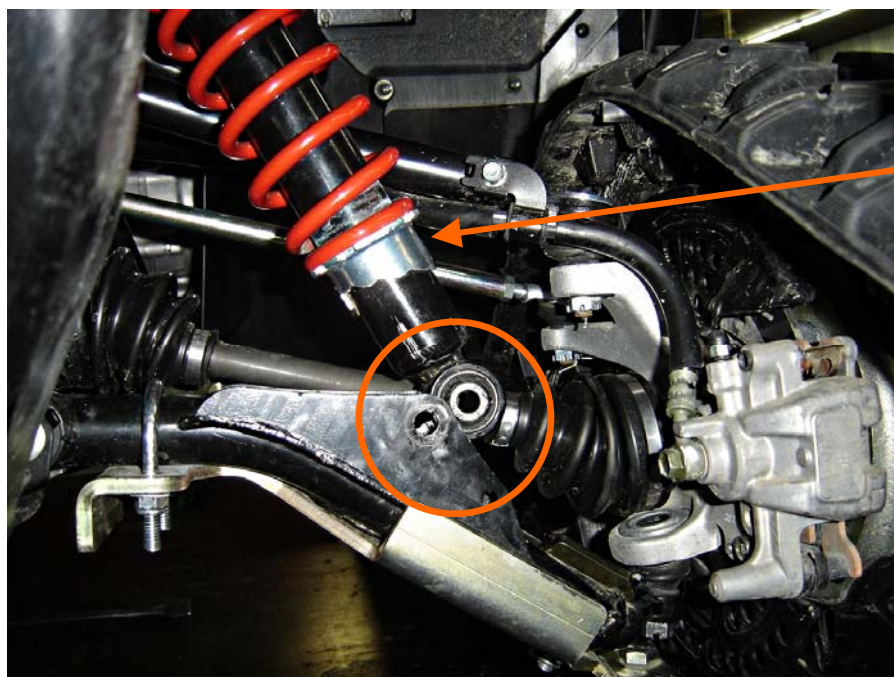

- To ease the installation, loosen the cylinder. (Item 4.)
- To release the cylinder, remove the original bolt. (See circle.)

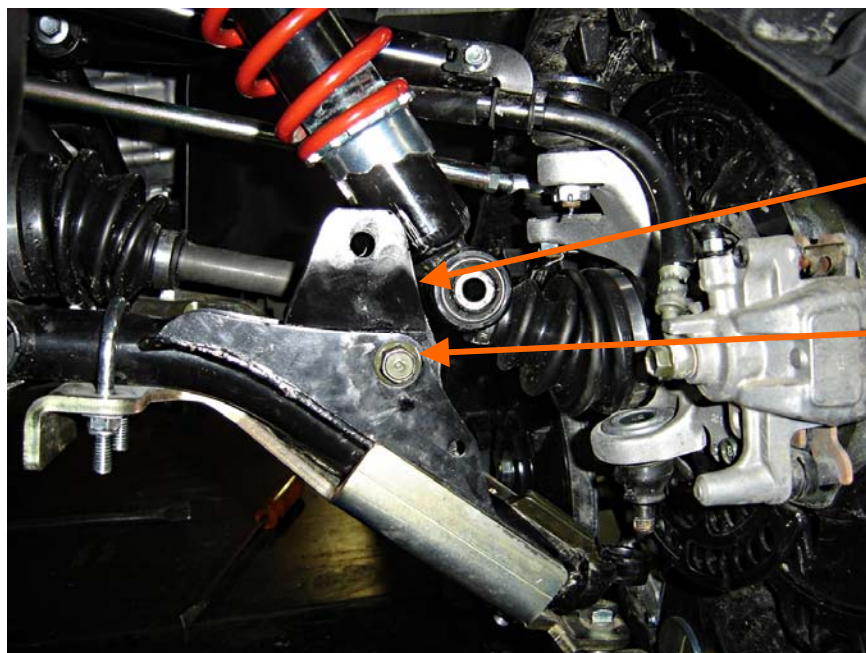

- Insert the lift kit (item 5) on the a-arm.
- Reinstall the original bolt. (item 6)



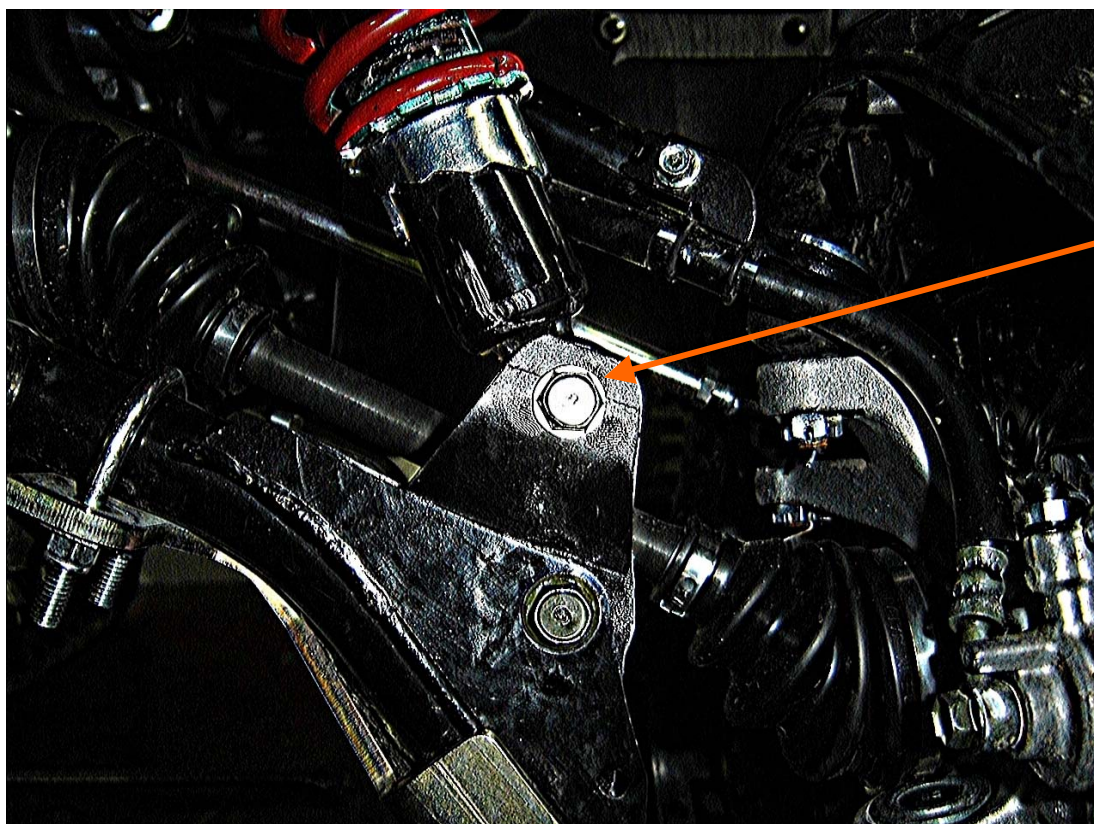

7

- Reassemble the second bolt. (item 7)

*important: do not tighten the bolt excessively because it will block the cylinder.

- Repeat the steps for other side of the vehicle.
- Adjust the suspension to it's maximum stiffness.

⚠ It's important to use this assembly with the xgen system only.

